

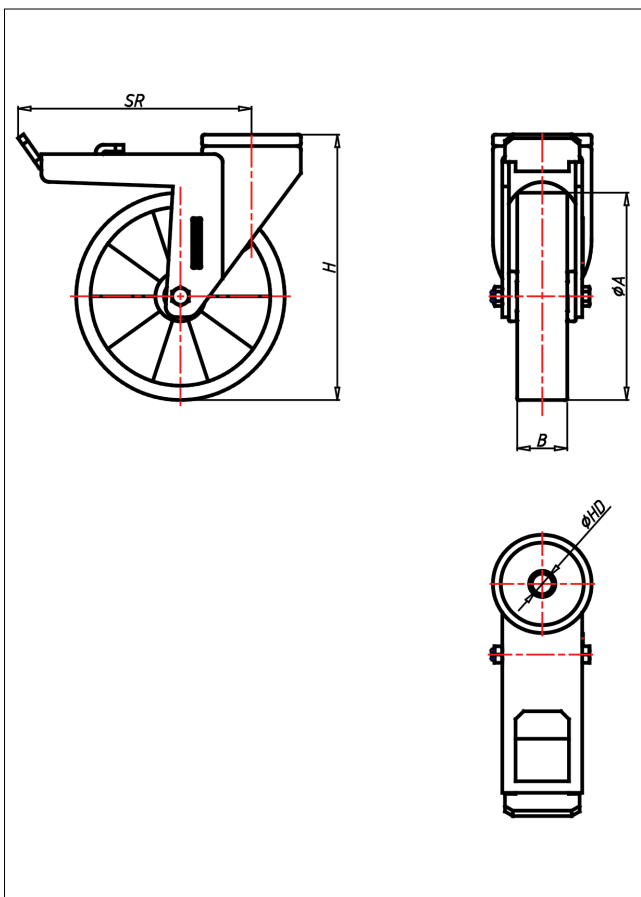

CRT/CRST-TLK/TLB

Lenkrolle mit Totalfeststeller



CR-TL



LENKROLLE	LENKROLLE MIT TOTALFESTSTELLER																					
<ul style="list-style-type: none"> geräuscharmer Lauf geringer Rollwiderstand abrieb- und reißfest hohe Stoßfestigkeit sehr beständig gegen viele aggressive Medien <p>Guss-Polyurethan Felge Spritzguss-Aluminium-Legierung → Seite 250</p>	<p>zweifaches Kugellager - vernietet Stahlkugeln gehärtet Radachse verschraubt, verzinkt</p> <p>→ Seite 62</p>	<p>AUSWAHLHILFE:</p> <table border="0"> <tr> <td>leicht lenkend</td> <td>-</td> <td>+</td> <td>+</td> </tr> <tr> <td>verschleißarm</td> <td>○</td> <td>○</td> <td>○</td> </tr> <tr> <td>stoßfest</td> <td>○</td> <td>○</td> <td>○</td> </tr> <tr> <td>bodenschonend</td> <td>○</td> <td>○</td> <td>○</td> </tr> <tr> <td>witterungsbeständig</td> <td>○</td> <td>○</td> <td>○</td> </tr> </table>	leicht lenkend	-	+	+	verschleißarm	○	○	○	stoßfest	○	○	○	bodenschonend	○	○	○	witterungsbeständig	○	○	○
leicht lenkend	-	+	+																			
verschleißarm	○	○	○																			
stoßfest	○	○	○																			
bodenschonend	○	○	○																			
witterungsbeständig	○	○	○																			

Technische Details

ORDERNO (Artikel-nummer)	CRST 101 TLB
WDAB (Rad-Ø A x Breite B / mm)	100x40
LC (Tragkraft / kg)	200
H (Bauhöhe H / mm)	129
HD (Loch-Ø / mm)	12.5
SR (Schwenkradius / mm)	140
WB (Radlager)	Rollenlager